

English Classic

Burlington®

DESCRIPTION

English Classic 1130 Floor Standing Vanity – 4 Drawers, Matte English White

PRODUCT CODE

ENG1130D4DB



FEATURES

- Dimensions - W 1130 x H 885 x D 500mm
- Available in 1130, 1350 or 1550mm widths – floor standing only.
- Available in single or double bowls – single bowl must be offset left or right.
- 25mm solid Kordura top with seamlessly integrated Inset basins.
- Cabinet features Edwardian design with Matte English White paint finish or in your choice of matte or satin paint colour.
- Soft-close drawers.
- Traditional handles - available in Chrome, Satin Black, Antique Bronze or Antique Pewter.
- Matches perfectly with our Burlington range.
- Pair with the English Classic mirror unit and tall cabinet.

PAINT FINISH



Matte English White



Custom Matte or Satin Colour

KORDURA TOP FINISHES



Matte White



Carrera Marble

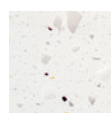

Ice Crystal



Ariston

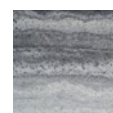

Akashi Grey

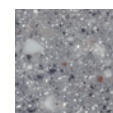

Peak Stone

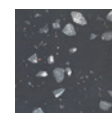

Black Granite

HANDLE OPTIONS



Chrome



Satin Black



Antique Bronze



Antique Pewter

NOTES

See following page for technical drawings. Tapholes do not come with predrilled – this is the responsibility of the installer, and can be cut with a hole saw, jigsaw or router. Excludes tapware & accessories.

DESCRIPTION

English Classic 1130 Floor Standing Vanity – 4 Drawers, Matte English White

PRODUCT CODE

ENG1130D4DB

TECHNICAL DRAWINGS

Top

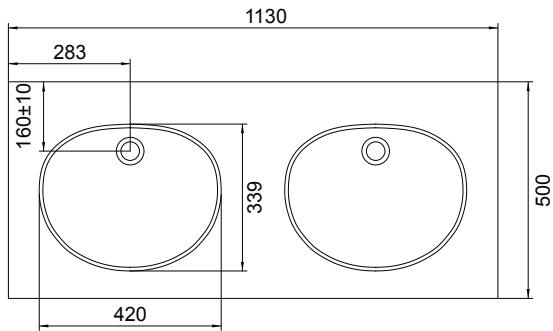

Side Section of Basin

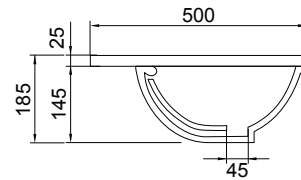

Front

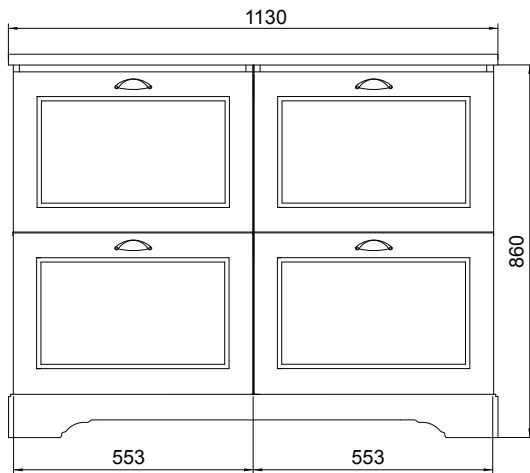

Side

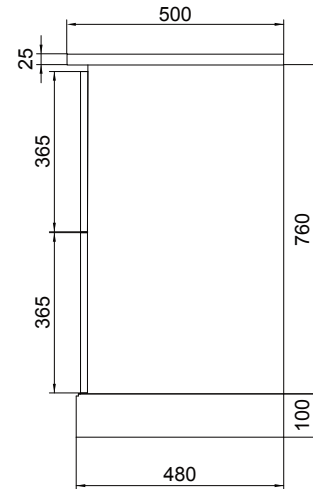

NOTES

Drawing indicates the technical measurement only and is not a reflection of how the unit will look. Sizes are nominal only. All drawings in millimeters. Drawings not to scale.