

ENGLISH CLASSIC /

Burlington®

DESCRIPTION

English Classic 600 Wall-Hung - 2 Drawers, Matte English White

PRODUCT CODE

ENG60D2WH



Dimensions	W 600 x H 632 x D 485 (mm)
Finishes	Matte English White or Matte Custom Colour*
Top	Ceramic top with integrated basin & overflow
Pull Handle	Polished Chrome, Satin Black, Antique Bronze or Antique Pewter
Origin	New Zealand made cabinetry
Features	<ul style="list-style-type: none">• Soft-close drawers• Edwardian detailing & traditional pull handle• Our signature hard paint finish is polyurethane or UV based & harder than traditional lacquered finishes• Perfectly pairs with our Burlington tapware & accessories range.

TECHNICAL DRAWINGS

Front

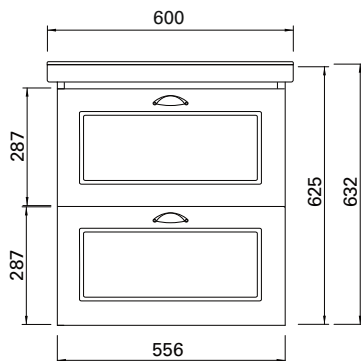

Side

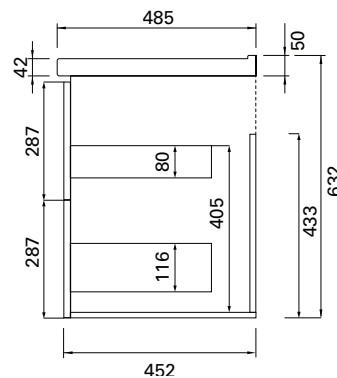

Drawers

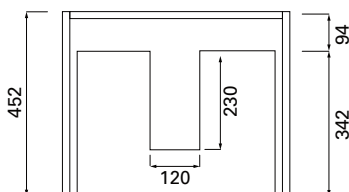

Basin Top

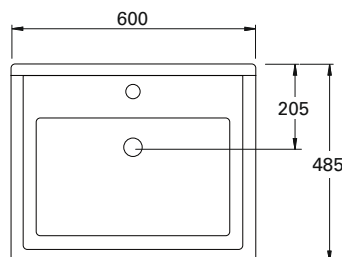

Basin Side Section

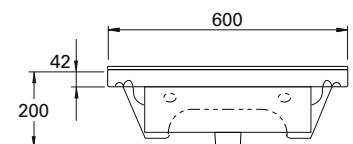

NOTES

*Additional Cost. Accessories not included. Drawing indicates the technical measurement only and is not a reflection of how the product will look. Sizes are nominal only. All drawings in millimeters. Drawings not to scale. Aug 2024.