

/FLOATING SHELVES/

LAUNDRY/

DESCRIPTION

Floating Shelves, 900mm, White / Timber Veneer

PRODUCT CODE

S90 / S90T



FEATURES

- Dimensions - W900 x H25 x D150
- Available painted White or in Timber Veneer.*
- The paint used on our products is polyurethane or UV based. Our high-tech process means each panel is painted and heated at least five times, then assembled into the units with a surface that feels silken to the touch.
- Timber veneer finishes are 100% natural, so each have variations in grain and colour, Satin or Gloss finish (Gloss finish 20% surcharge). All come stained and sealed with a protective UV finish.

TECHNICAL DRAWINGS

Top

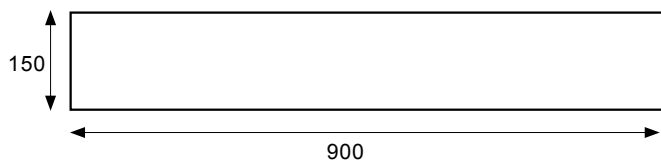

Fixing Mechanism

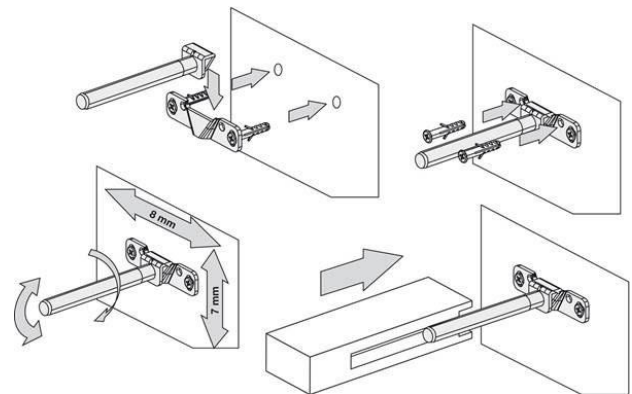

Front

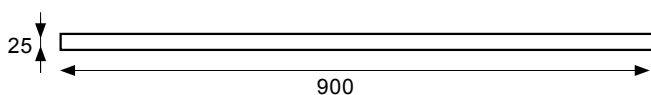

NOTES

*Non-stock item. Sizes approximate. All drawings in millimeters. Drawing indicates the technical measurement only and is not a reflection of how the product will look.